



**WANSEMI**  
万芯半导体

**WP3020K**

# **Enhancement Mode N-Channel Power MOSFET**

TO-252/NMOS/30V/ $\pm 20V$ /1.7V/20A/8.7m $\Omega$

Rev0.6

---

## 30V, 8.7mΩ, 20A, Single N-Channel

### 1.Features

- ◆ 30V MOSFET technology
- ◆ Low on-state resistance
- ◆ Fast switching
- ◆  $V_{GS} \pm 20V$

$V_{DS}$	$R_{DS(on)}$ Typ.	$I_D$ Max.
30V	8.7mΩ @ 10V	20A
	13.5mΩ @ 4.5V	

### 2.Applications

- ◆ Power Switching Application
- ◆ Load Switching

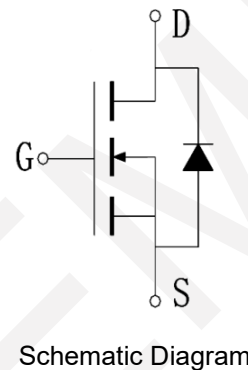

### 3.Package Marking and Ordering Information

Part no.	Marking	Package	PCS/Reel	PCS/CTN.
WP3020K	WP3020K	TO-252	2,500	25,000

### 4.Absolute Max Ratings at $T_a=25^\circ C$ (Note1)

Parameter	Symbol	Maximum	Units
Drain to Source Voltage	$V_{DSS}$	30	V
Gate to Source Voltage	$V_{GSS}$	$\pm 20$	V
Drain Current (DC)	$I_D$	20	A
Drain Current (Pulse), $PW \leq 300\mu s$	$I_{DP}$	80	A
Total Dissipation	$P_D$	69	W
Avalanche Energy, Single Pulsed	$E_{AS}$	64	mJ
Junction Temperature	$T_j$	150	$^\circ C$
Storage Temperature	$T_{stg}$	-55 to +150	$^\circ C$

Note 1: Stresses exceeding those listed in the Maximum Ratings table may damage the device. If any of these limits are exceeded, device functionality should not be assumed, damage may occur and reliability may be affected.

### 5. Thermal Resistance Ratings

Parameter	Symbol	Value	Unit
Junction to case	$R_{\theta JC}$	1.8	$^{\circ}C/W$

Note 2: When mounted on 1 inch square copper board  $t \leq 10$ sec The value in any given application depends on the user's specific board design.

### 6. Electrical Characteristics at $T_a=25^{\circ}C$ (Note 3)

Parameter	Symbol	Test Conditions	Min.	Typ.	Max.	Units
Drain to Source Breakdown Voltage	$V_{(BR)DSS}$	$I_D = 250\mu A, V_{GS} = 0V$	30	-	-	V
Zero-Gate Voltage Drain Current	$I_{DSS}$	$V_{DS} = 30V, V_{GS} = 0V$	-	-	1	$\mu A$
Gate to Source Leakage Current	$I_{GSS}$	$V_{GS} = \pm 20V, V_{SS} = 0V$	-	-	$\pm 100$	nA
Gate Threshold Voltage	$V_{GS(th)}$	$V_{DS}=V_{GS}, I_{DS}=250\mu A$	1.2	1.7	2.5	V
Static Drain to Source On-State Resistance	$R_{DS(on)}$	$I_D = 10A, V_{GS} = 10V$	-	8.7	10	m $\Omega$
		$I_D = 5A, V_{GS} = 4.5V$	-	13.5	15.5	m $\Omega$
Input Capacitance	$C_{iss}$	$V_{GS}=0V,$ $V_{DS}=15V,$ Frequency=1.0MHz	-	850	-	pF
Output Capacitance	$C_{oss}$		-	106	-	pF
Reverse Transfer Capacitance	$C_{rss}$		-	80	-	pF
Turn-ON Delay Time	$t_{d(on)}$		-	6	-	ns
Rise Time	$t_r$	$V_{DS} = 10V, V_{GS} = 15V,$ $R_G = 3\Omega$	-	15	-	ns
Turn-OFF Delay Time	$t_{d(off)}$		-	17	-	ns
Fall Time	$t_f$		-	5	-	ns
Total Gate Charge	$Q_g$	$V_{DS} = 15V,$ $V_{GS} = 0$ to 10V, $I_D = 15A$	-	16	-	nC
	$Q_{gs}$		-	3.6	-	nC
	$Q_{gd}$		-	3.4	-	nC
Diode Forward Voltage	$V_{FSD}$	$I_S=10A, V_{GS} = 0$	0.4	0.8	1.2	V

Note 3: Product parametric performance is indicated in the Electrical Characteristics for the listed test conditions, unless otherwise noted. Product performance may not be indicated by the Electrical Characteristics if operated under different conditions.



### 7. Typical electrical and thermal characteristics

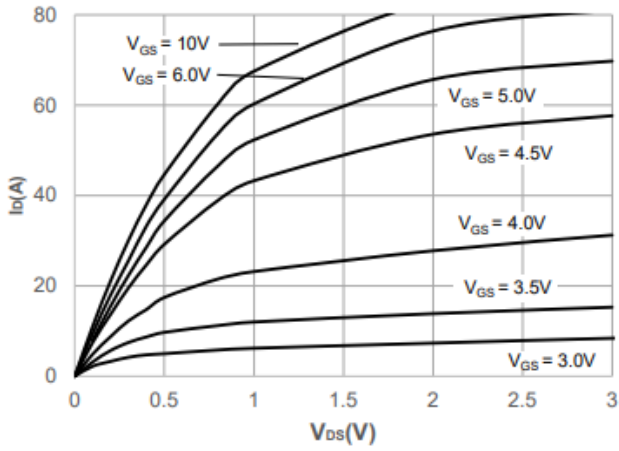

Output Characteristics

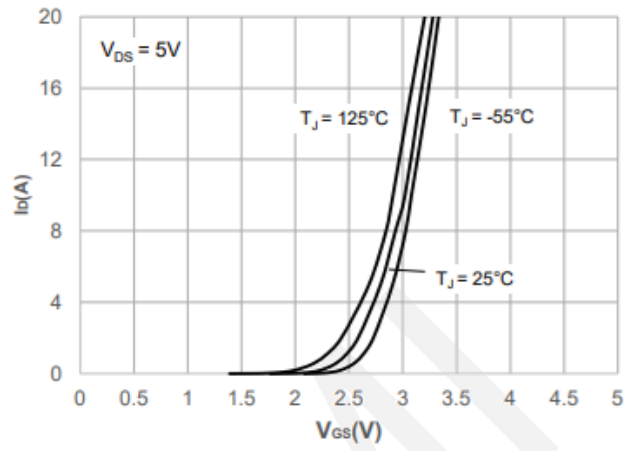

Transfer Characteristics

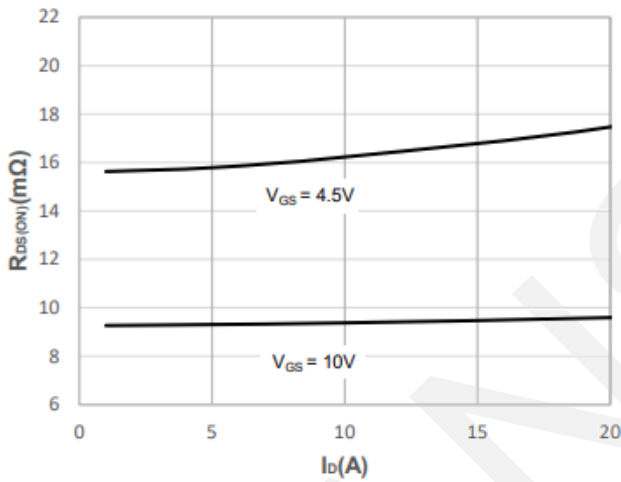

Rdson-Drain Current

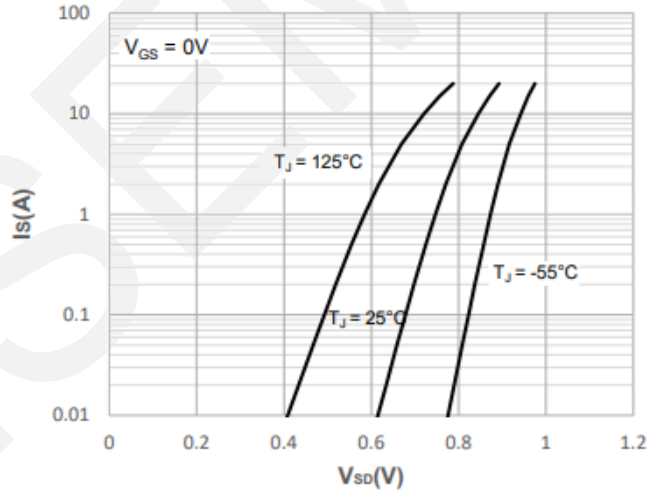

Body Diode Characteristics

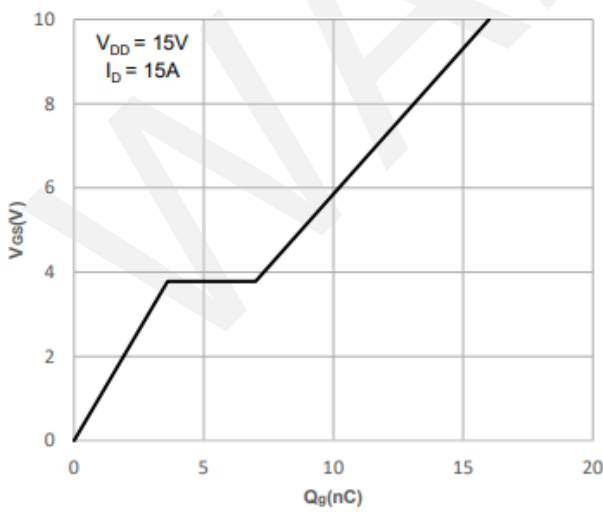

Gate Charge

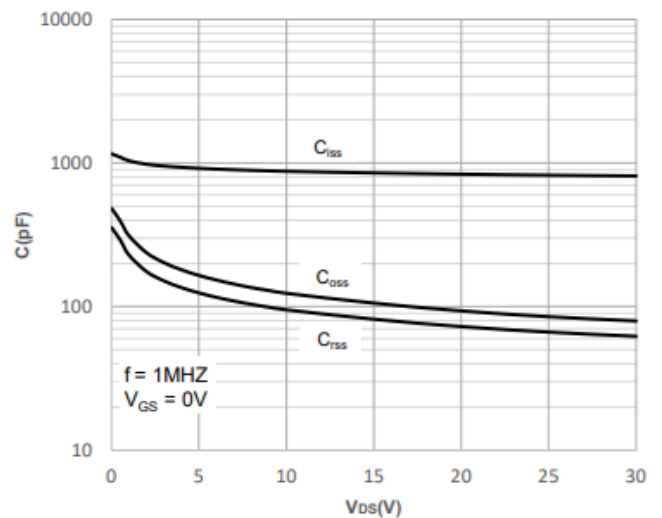

Capacitance Characteristics

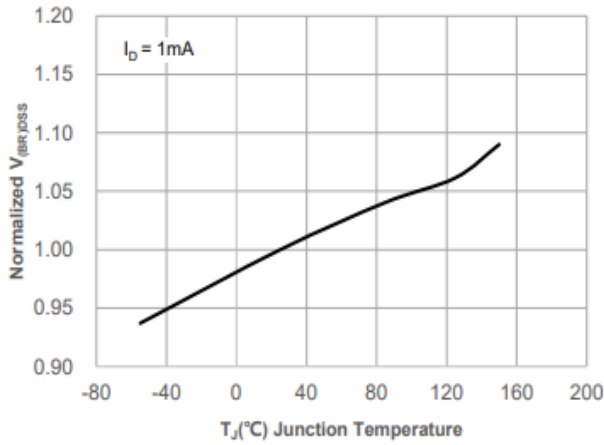

**Normalized Breakdown voltage vs. Junction Temperature**

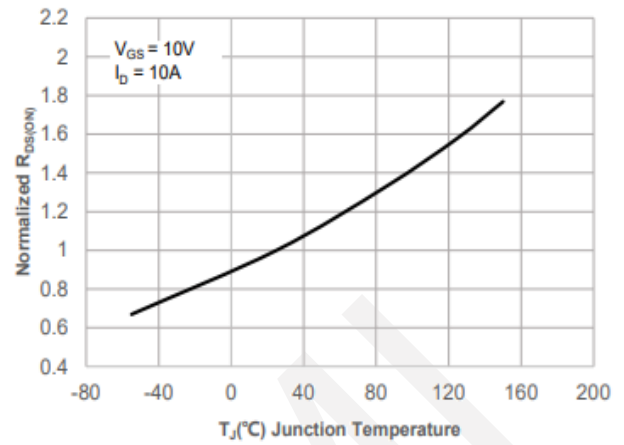

**Normalized on Resistance vs. Junction Temperature**

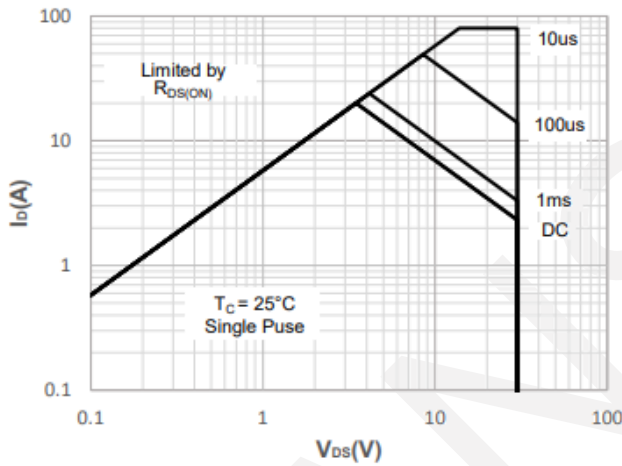

**Maximum Safe Operating Area**

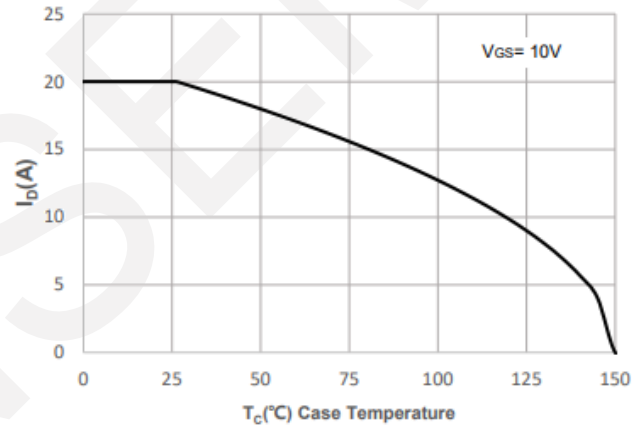

**Maximum Continuous Drain Current vs. Case Temperature**

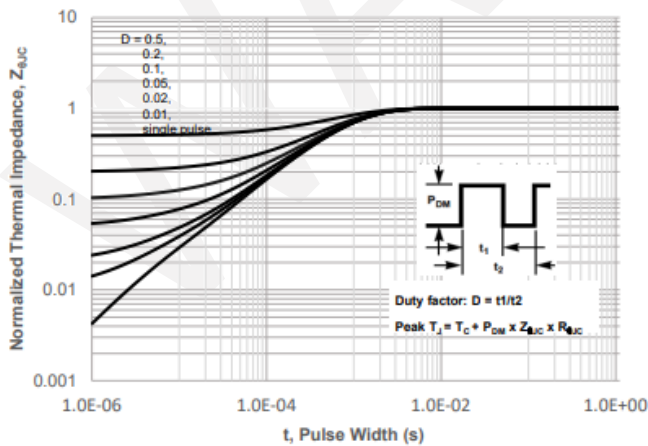

**Normalized Maximum Transient Thermal Impedance**

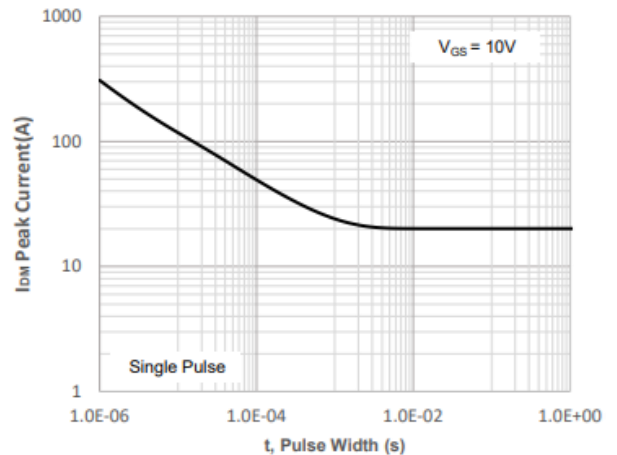

**Peak Current Capacity**



**8.Package Dimensions**

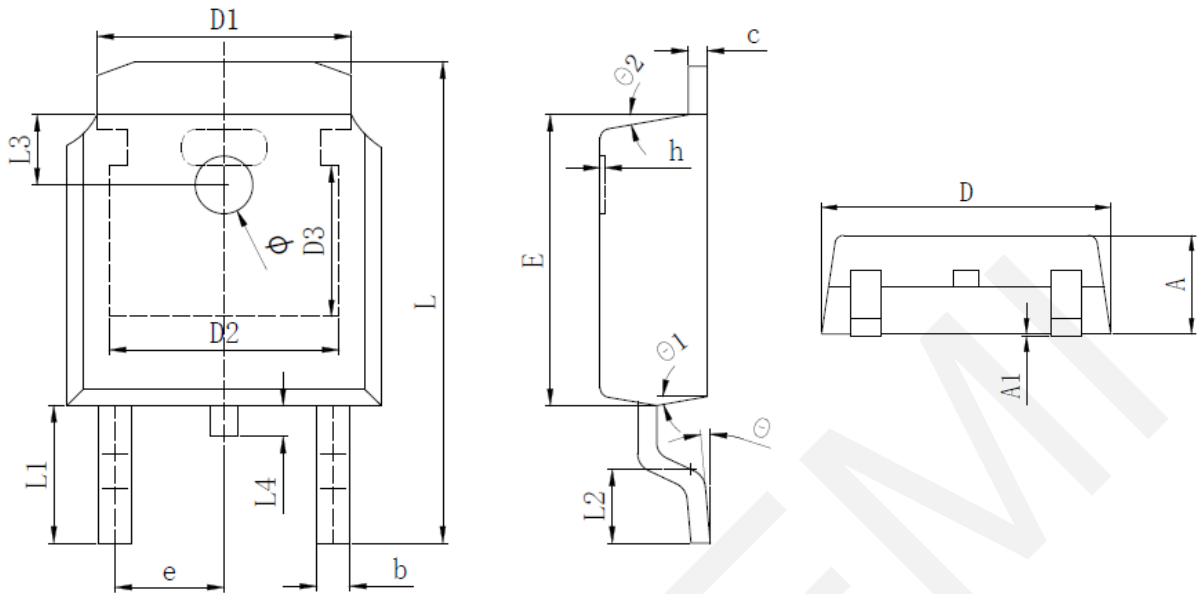

SYMBOL	MILLIMETER		
	MIN	Typ.	MAX
A	2.200	2.300	2.400
A1	0.000		0.127
b	0.640	0.690	0.740
c(电镀后)	0.460	0.520	0.580
D	6.500	6.600	6.700
D1	5.334 REF		
D2	4.826 REF		
D3	3.166 REF		
E	6.000	6.100	6.200
e	2.286 TYP		
h	0.000	0.100	0.200
L	9.900	10.100	10.300
L1	2.888 REF		
L2	1.400	1.550	1.700
L3	1.600 REF		
L4	0.600	0.800	1.000
φ	1.100	1.200	1.300
θ	0°		8°
θ 1	9° TYP		
θ 2	9° TYP		

## 9. Important Notice

WAN SEMICONDUCTOR (NINGBO) CO.,LTD reserves the right to make corrections, enhancements, improvements and other changes to its semiconductor products and services and to discontinue any product or service. Buyers should obtain the latest relevant information before placing orders and should verify that such information is current and complete. All semiconductor products (also referred to herein as “components”) are sold subject to WANSEMI’s terms and conditions of sale supplied at the time of order acknowledgment.

WANSEMI warrants performance of its components to the specifications applicable at the time of sale, in accordance with the warranty in WANSEMI’s terms and conditions of sale of semiconductor products. Testing and other quality control techniques are used to the extent WANSEMI deems necessary to support this warranty. Except where mandated by applicable law, testing of all parameters of each component is not necessarily performed.

WANSEMI assumes no liability for applications assistance or the design of Buyers’ products. Buyers are responsible for their products and applications using WANSEMI components. To minimize the risks associated with Buyers’ products and applications, Buyers should provide adequate design and operating safeguards.

No WANSEMI components are authorized for use in FDA Class III (or similar life-critical medical equipment) unless authorized officers of the parties have executed a special agreement specifically governing such use.

Unless WANSEMI has specifically designated certain components which meet ISO/TS16949 requirements, mainly for automotive use, WANSEMI will not be responsible for any failure of such components to meet such requirements.