



WANSEMI
万芯半导体

WX062P03S3

Enhancement Mode P-Channel Power MOSFET

SOT23-3/PMOS/-30V/±20V/-1.7V/-3A/62mΩ

Rev0.1

-30V, 62mΩ, -3A, P-Channel MOSFET

1.Features

- ◆ Advanced Trench Technology
- ◆ Surface mount package

2.Applications

- ◆ Power Management
- ◆ Load Switching

V_{DS}	$R_{DS(on)}$ Typ.	I_D
-30V	62mΩ @ -10V	-3A
	87mΩ @ -4.5V	

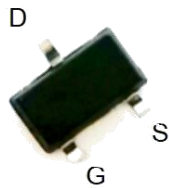

SOT23-3

Pin Description

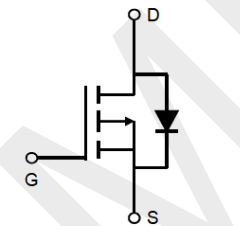

Schematic Diagram

3.Package Marking and Ordering Information

Part no.	Marking	Package	PCS/Reel	PCS/CTN.
WX062P03S3	062P03	SOT23-3	3,000	180,000

4.Absolute Max Ratings at Ta=25°C (Note1)

Parameter	Symbol	Maximum	Units
Drain to Source Voltage	V_{DSS}	-30	V
Gate to Source Voltage	V_{GSS}	±20	V
Drain Current (DC)	I_D	-3	A
Drain Current (Pulse), $PW \leq 300\mu s$	I_{DP}	-12	A
Total Dissipation	P_D	19	W
Junction Temperature	T_j	150	°C
Storage Temperature	T_{stg}	-55 to +150	°C

Note 1: Stresses exceeding those listed in the Maximum Ratings table may damage the device. If any of these limits are exceeded, device functionality should not be assumed, damage may occur and reliability may be affected.

5.Thermal Resistance Ratings (Note 2)

Parameter	Symbol	Value	Unit
Junction to Ambient	$R_{\theta JA}$	70	°C/W

Note 2: When mounted on 1 inch square copper board $t \leq 10\text{sec}$ The value in any given application depends on the user's specific board design.

6. Electrical Characteristics at Ta=25°C (Note 3)

Parameter	Symbol	Test Conditions	Min.	Typ.	Max.	Units
Drain to Source Breakdown Voltage	$V_{(BR)DSS}$	$I_D = -250\mu A, V_{GS} = 0V$	-30	-	-	V
Zero-Gate Voltage Drain Current	I_{DSS}	$V_{DS} = -30V, V_{GS} = 0V$	-	-	-1	μA
Gate to Source Leakage Current	I_{GSS}	$V_{GS} = \pm 20V, V_{DS} = 0V$	-	-	± 100	nA
Gate Threshold Voltage	$V_{GS(th)}$	$V_{DS}=V_{GS}, I_{DS}=-250\mu A$	-1.0	-1.7	-2.5	V
Static Drain to Source On-State Resistance	$R_{DS(on)}$	$I_D = -3A, V_{GS} = -10V$	-	62	80	m Ω
		$I_D = -2A, V_{GS} = -4.5V$	-	87	113	m Ω
Input Capacitance	C_{iss}	$V_{GS}=0V,$ $V_{DS}=-15V,$ Frequency=1.0MHz	-	262	-	pF
Output Capacitance	C_{oss}		-	42	-	pF
Reverse Transfer Capacitance	C_{rss}		-	31	-	pF
Turn-ON Delay Time	$t_{d(on)}$	$V_{DD} = -15V, I_D = -3A,$ $R_G = 3\Omega, V_{GS} = -10V$	-	2.6	-	ns
Rise Time	t_r		-	1.3	-	ns
Turn-OFF Delay Time	$t_{d(off)}$		-	11	-	ns
Fall Time	t_f		-	4.2	-	ns
Total Gate Charge	Q_g	$V_{DS} = -15V,$ $V_{GS} = 0 \text{ to } -10V,$ $I_D = -3A$	-	5.7	-	nC
	Q_{gs}		-	1.1	-	nC
	Q_{gd}		-	1.2	-	nC
Diode Forward Voltage	V_{FSD}	$I_{SD} = -3A, V_{GS} = 0$	-0.5	-	-1.2	V

Note 3: Product parametric performance is indicated in the Electrical Characteristics for the listed test conditions, unless otherwise noted. Product performance may not be indicated by the Electrical Characteristics if operated under different conditions.



7. Typical Electrical and Thermal Characteristics

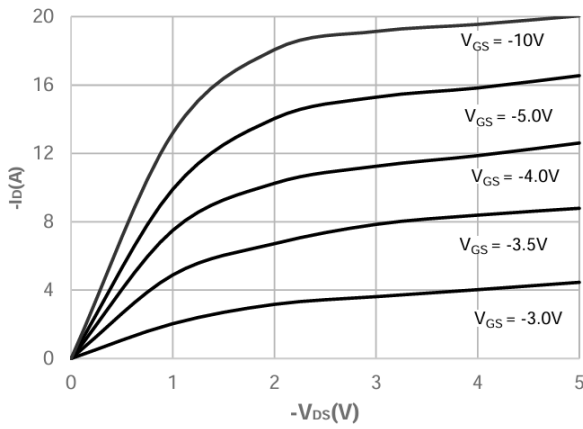

Typical Output Characteristics

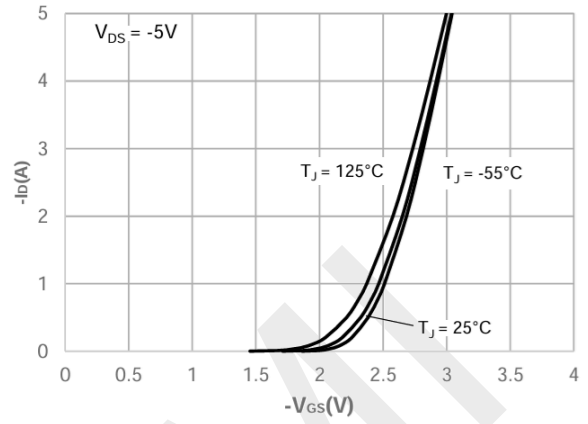

Typical Transfer Characteristics

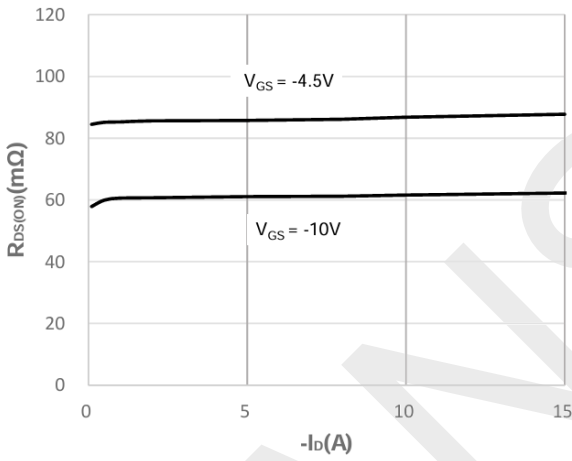

On-resistance vs. Drain Current

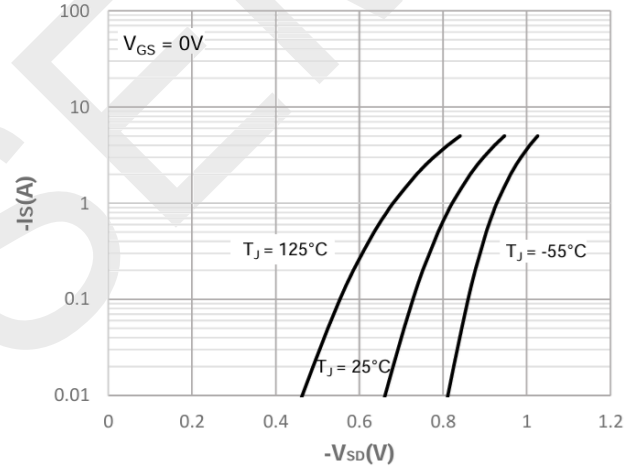

Body Diode Characteristics

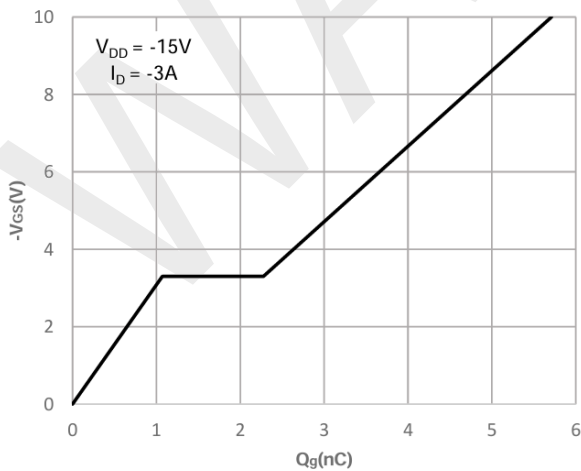

Gate Charge Characteristics

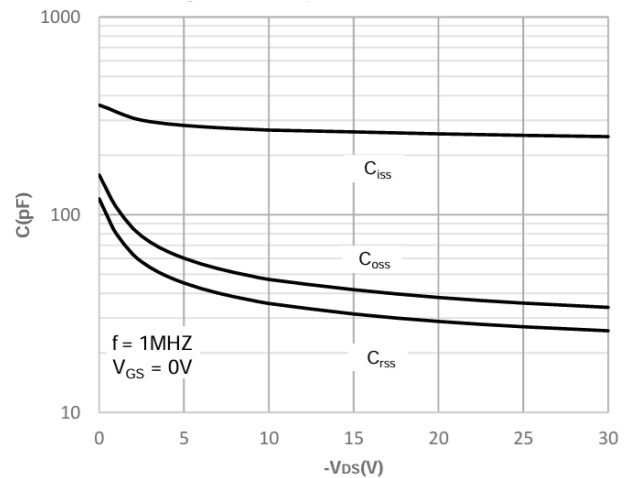

Capacitance Characteristics

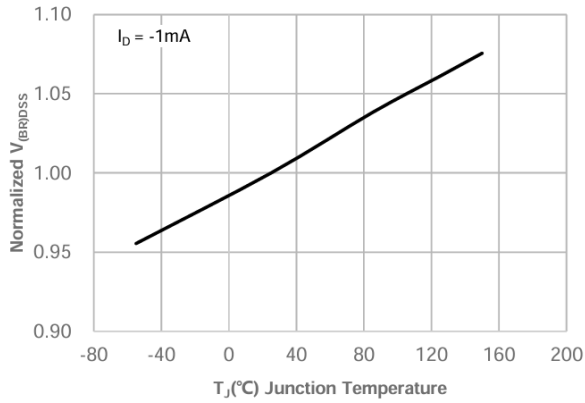

Normalized Breakdown voltage vs. Junction Temperature

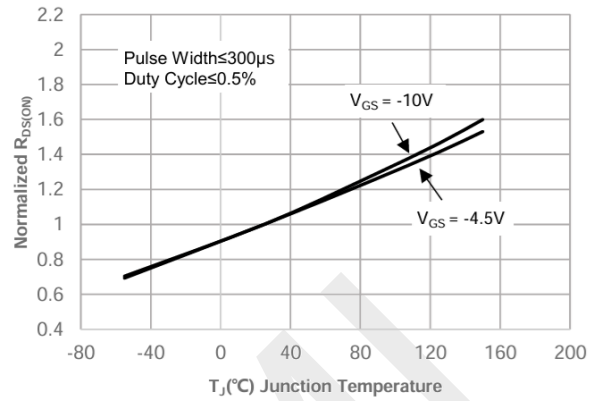

Normalized on Resistance vs. Junction Temperature

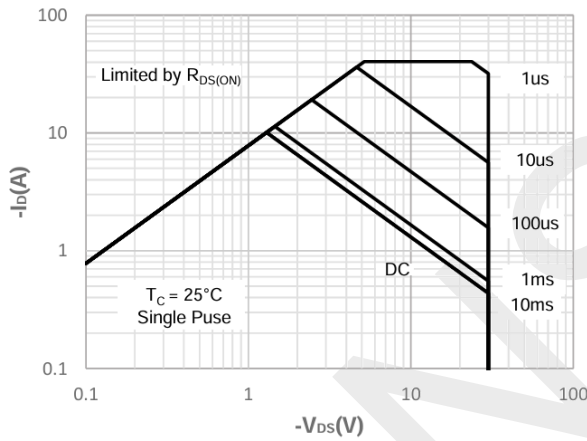

Normalized Breakdown voltage vs. Junction Temperature

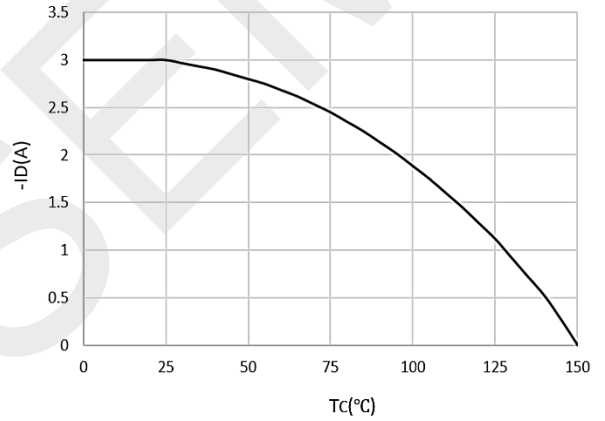

Current De-rating

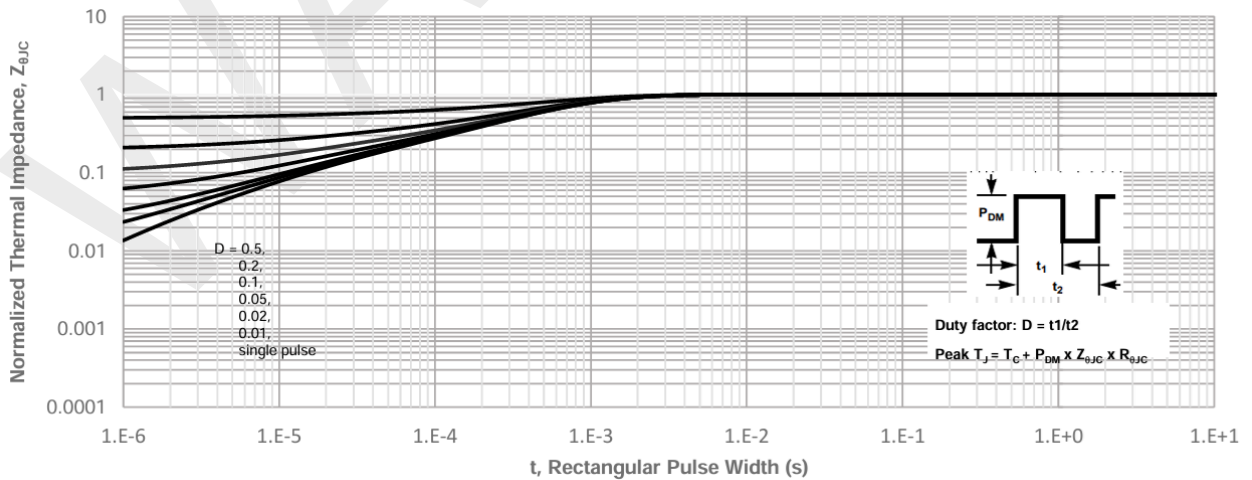

Normalized Maximum Transient Thermal Impedance

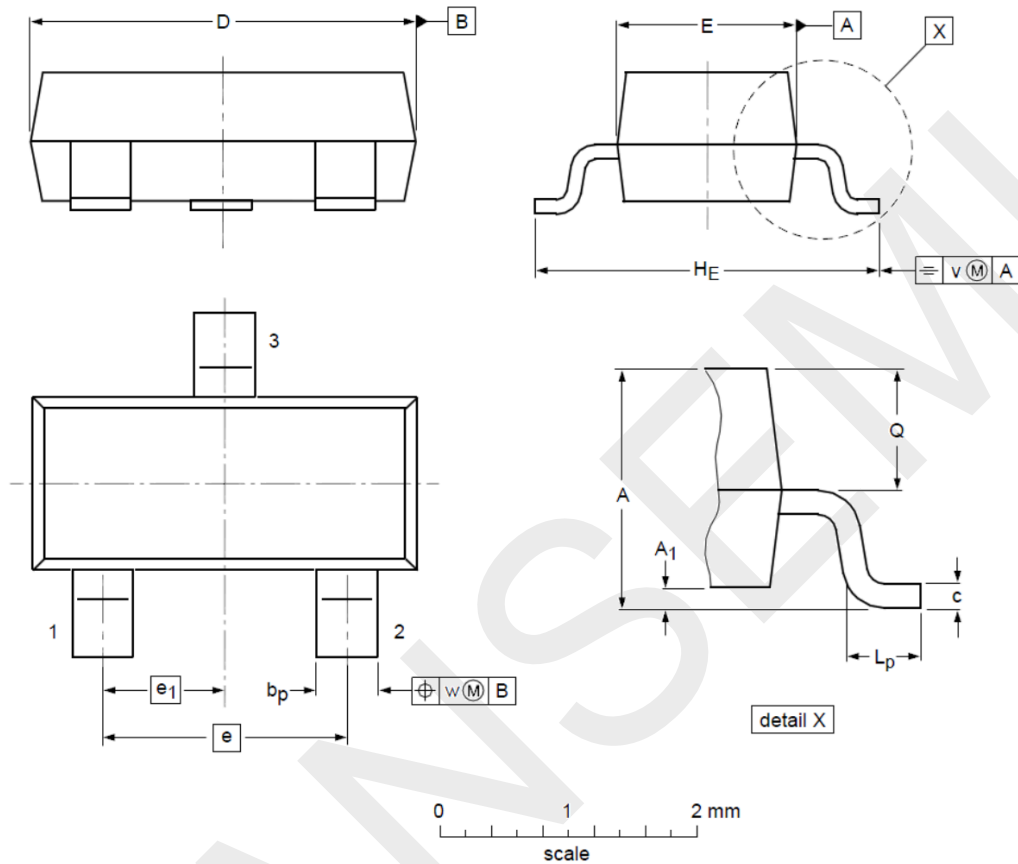
8.Package Dimensions

DIMENSIONS (unit : mm)

Symbol	Min	Typ	Max	Symbol	Min	Typ	Max
A	1.00	1.17	1.30	A ₁	0.01	0.05	0.10
b _p	0.35	0.39	0.50	c	0.10	0.20	0.26
D	2.70	2.90	3.10	E	1.30	1.58	1.70
e	--	1.90	--	e ₁	--	0.95	--
H _E	2.50	2.78	3.00	L _p	0.20	0.32	0.60
Q	0.23	0.27	0.33	v	--	0.20	--
w	--	0.20	--				

9. Important Notice

WAN SEMICONDUCTOR (NINGBO) CO.,LTD reserves the right to make corrections, enhancements, improvements and other changes to its semiconductor products and services and to discontinue any product or service. Buyers should obtain the latest relevant information before placing orders and should verify that such information is current and complete. All semiconductor products (also referred to herein as “components”) are sold subject to WANSEMI’s terms and conditions of sale supplied at the time of order acknowledgment.

WANSEMI warrants performance of its components to the specifications applicable at the time of sale, in accordance with the warranty in WANSEMI’s terms and conditions of sale of semiconductor products. Testing and other quality control techniques are used to the extent WANSEMI deems necessary to support this warranty. Except where mandated by applicable law, testing of all parameters of each component is not necessarily performed.

WANSEMI assumes no liability for applications assistance or the design of Buyers’ products. Buyers are responsible for their products and applications using WANSEMI components. To minimize the risks associated with Buyers’ products and applications, Buyers should provide adequate design and operating safeguards.

No WANSEMI components are authorized for use in FDA Class III (or similar life-critical medical equipment) unless authorized officers of the parties have executed a special agreement specifically governing such use.

Unless WANSEMI has specifically designated certain components which meet ISO/TS16949 requirements, mainly for automotive use, WANSEMI will not be responsible for any failure of such components to meet such requirements.